

COLOR LEGEND	
Green	Indicators (not printed)
Magenta	Body Border (not printed)

REV	DATE
1	26/11/19
2	03/01/20
3	21/01/20
4	31/03/20
5	05/06/20
6	29/06/20
7	03/07/20
8	07/07/20

## [EN] Installing a Yale Linus® Adjustable Cylinder

Video instructions on how to assemble the cylinder and install the Yale Linus® lock can also be found on the Yale Access app. It can be downloaded from the Google Play store or Apple App store.



### 01

Before we start, please measure how far your existing cylinder sticks out from your door furniture. If it is less than 3mm, please keep this in mind for later in the installation process.

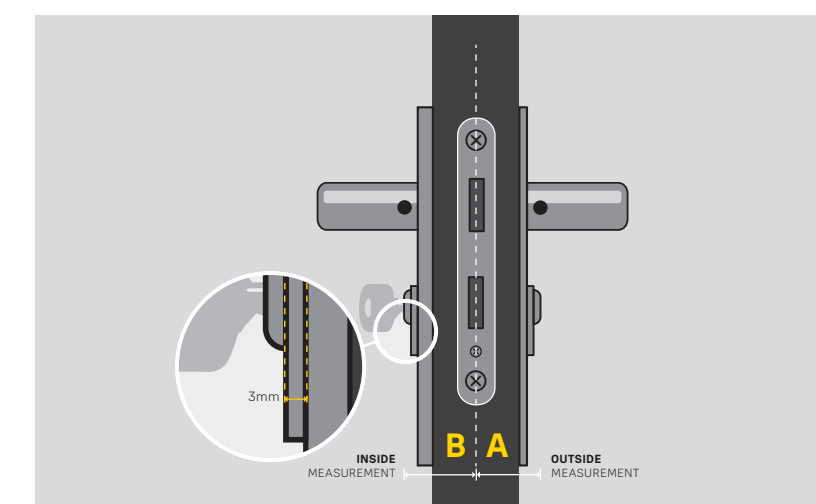

Google and the Google Play logo are trademarks of Google LLC. Apple, the Apple logo, iPhone, and iPad are trademarks of Apple Inc., registered in the U.S. and other countries and regions. App Store is a service mark of Apple Inc.

### 02

You will need to loosen your current door furniture (cylinder rose/handle), this will allow you to easily remove your current cylinder. The screws to loosen the current furniture are normally on the furniture on the internal side of the door. Next remove your existing cylinder. To do this unscrew the cylinder fixing screw. This can normally be found below the bolt on the lock (see diagram above). You will then probably need to insert and turn or jiggle the key to allow you to pull the cylinder from the door.

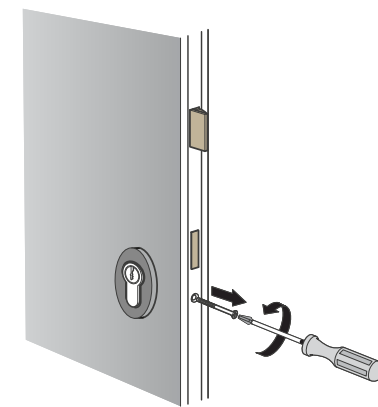

### 03

Now measure the size of your existing cylinder by measuring the length of each half, to the centre of the cam. This will give you two measurements, for example – 60mm and 40mm. It is important to know which measurement is for the external side and which one is for the internal side so that you adjust the cylinder correctly. If during the first step your cylinder protruded from the internal side of the door by less than 3mm, you will at this stage need to add an additional 3mm to your internal measurement. This ensures that the Linus® lock can easily attach to the cylinder later.

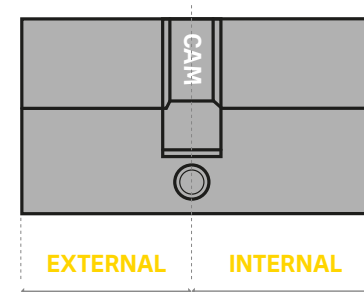

### 04

If your measurements are 30mm on the external length and 30mm on the internal length you don't need to do anything. The adjustable cylinder can be fitted as it is. Please skip to step 09. If your external measurement is more than 30mm, please add the external spacers together to form the difference between 30mm and your current cylinder's external length. For example if your current cylinder has an external length of 45mm, you would need to use both the 10mm and 5mm external spacer. If your cylinder length was in-between two sizes of spacers, please use the longer size.

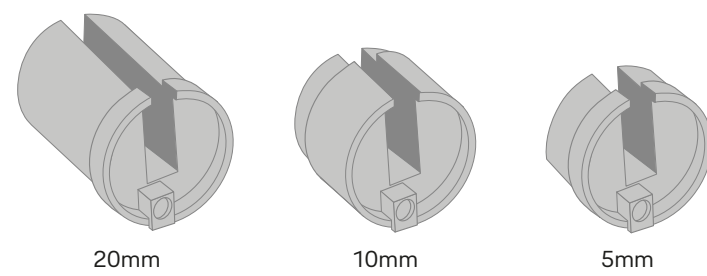

### 05

Next, pick the external faceplate that you require. If the external length of your existing cylinder is between 35mm and 45mm, please use the shorter faceplate. If it was between 50mm and 60mm please use the longer faceplate.

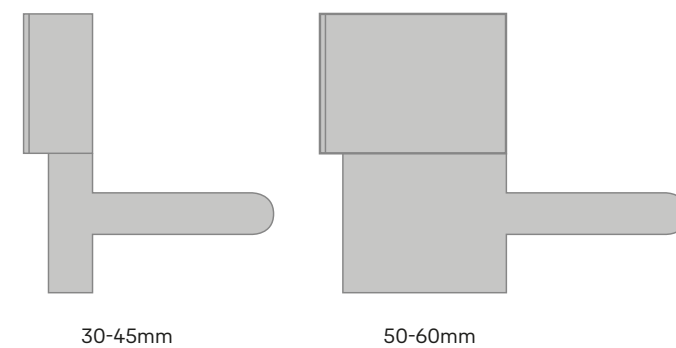

### 06

Using the small Allen key, loosen the screws at the bottom of the cylinder (see red arrow) until both filler pieces can be removed (see yellow arrow).

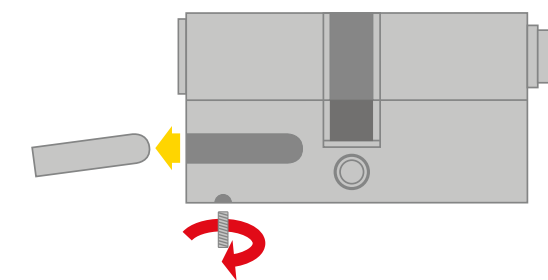

### 07

Using the table below as a guide, assemble the external spacers with the external faceplate onto the cylinder (see yellow arrow), making sure that the smallest external spacer is closest to the cylinder. Secure in place with the screws at the bottom of the cylinder (see red arrow below).

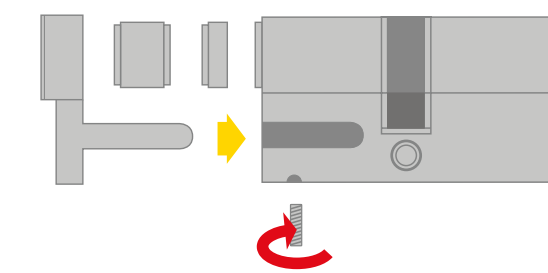

External Cylinder Size	5mm Extension	10mm Extension	20mm Extension
30mm	-	-	-
35mm	Yes	-	-
40mm	-	Yes	-
45mm	Yes	Yes	-
50mm	-	-	Yes
55mm	Yes	-	Yes
60mm	-	Yes	Yes

### 08

Once you have assembled your new cylinder, insert the key in the external side of cylinder and make sure it can turn the cylinder freely.

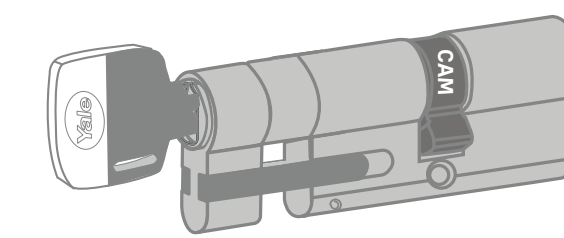

### 09

If the internal measurement of your existing cylinder is more than 30mm including the 3mm mentioned in step 3, please add the internal spacers together to form the difference between 30mm and your current cylinder's internal length. For example if your current cylinder has an internal length of 45mm, you would need to use both the 10mm and 5mm internal spacer. If your cylinder length was in-between two sizes of spacers, please use the longer size.

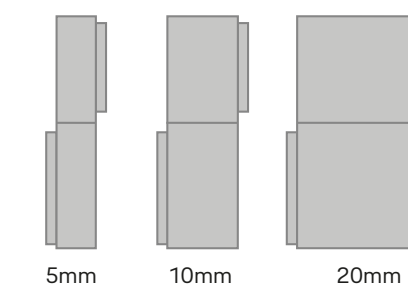

### 10

Next assemble the internal side of your cylinder using the correct spacers for your door (the size of the spacer is printed on the side of the spacer), securing them in place with either the short silver screw or the longer silver screw through the central hole with the larger allen key. The smallest spacer should be closest to the cylinder.

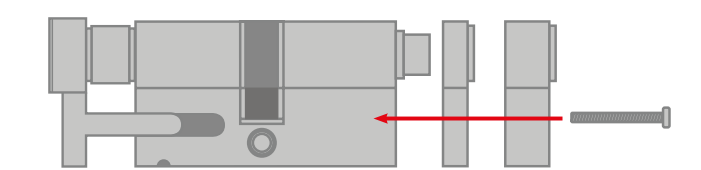

### 11

After you have fully assembled your cylinder, please insert the tailbar into the cylinder. If your internal measurement was 45mm or under please use the shorter tailbar that was provided, if not please use the larger one. Then make sure you can turn the cylinder freely using the tailbar.

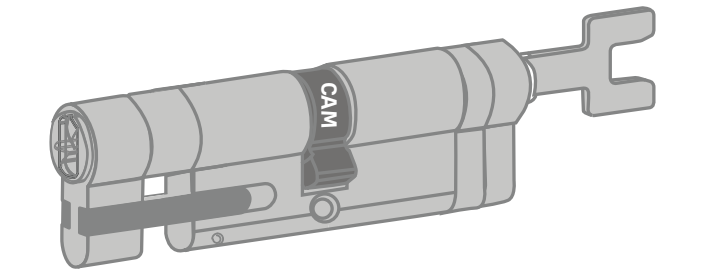

COLOR LEGEND	
Green	Indicators (not printed)
Magenta	Body Border (not printed)

REV	DATE
1	26/11/19
2	03/01/20
3	21/01/20
4	31/03/20
5	05/06/20
6	29/06/20
7	03/07/20
8	07/07/20

### 12

Go to the internal side of your door, and turn the tailbar so that the cam lines up with the body of the cylinder to allow it to fit inside the hole in your door. You may need to turn or jiggle the tailbar to get the cylinder into place.

You may also need to loosen your current door furniture (rose/handles) if it is tight around the cylinder.

Secure the cylinder in place with the cylinder fixing screw, and tighten the door furniture on the door.

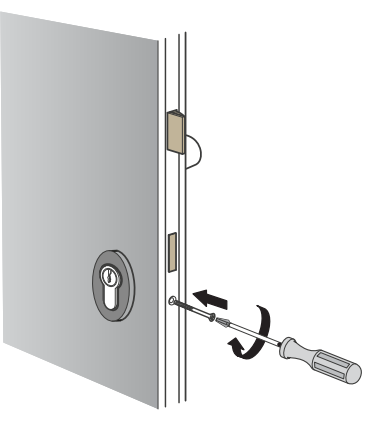

### 14

Add the mounting plate onto the internal side of the cylinder making sure that you have 3mm extended in order to fix the mounting plate. Fix the plate in place with the two small black screws.

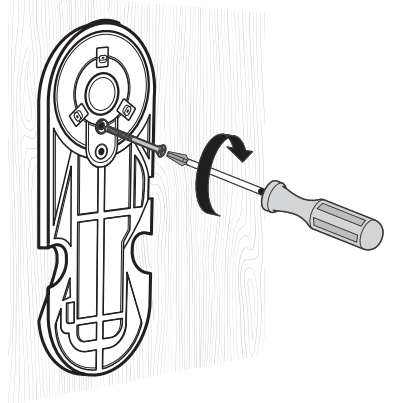

### 16

Mount the Linus® onto the fixing plate pushing the top of the unit onto the mounting plate first.

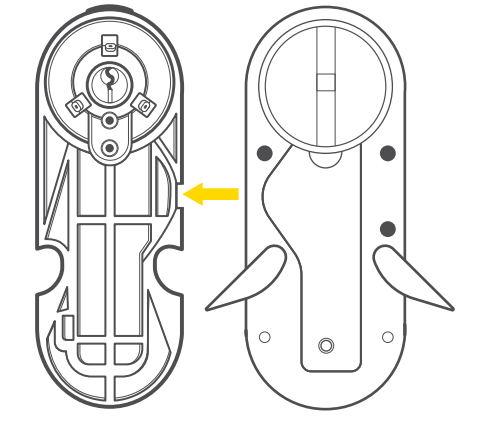

### 18

Peel the backing film from the Doorsense magnet and stick it on the door frame, level with the Yale logo on the Linus® lock.

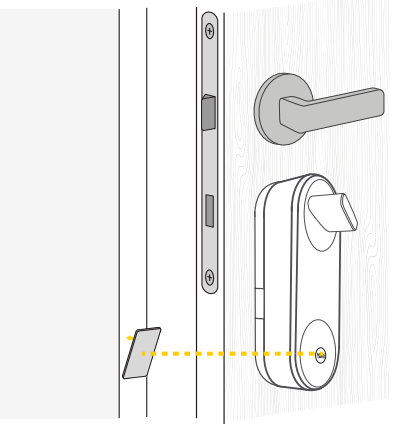

### 13

Take the Linus® unit out of the box and open the wings to remove the fixing plate.

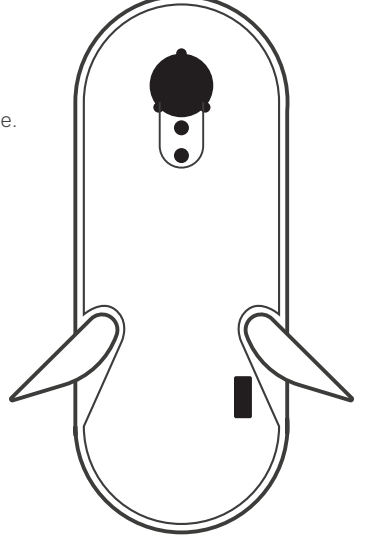

### 15

Add the tailbar to the internal side of the cylinder, making sure it can turn the cylinder freely. If the internal measurement is below 45mm use the short tailbar, above then use the long tailbar.

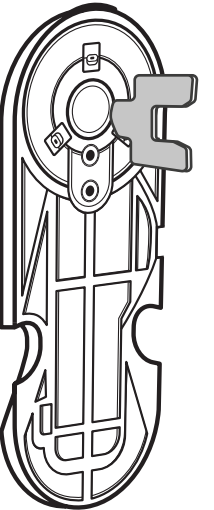

### 17

Close the 'wings' on the Linus® unit to securely fix it in place.

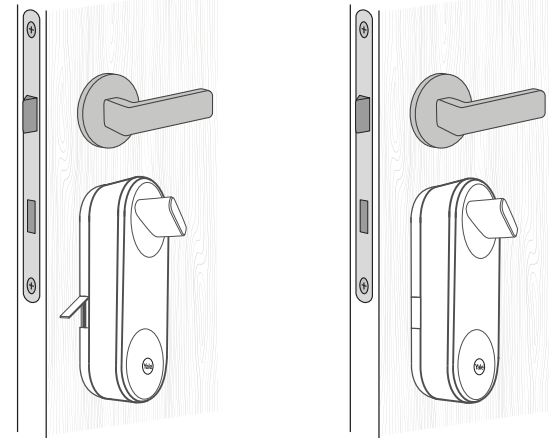

### 19

Please continue setup of the Linus® unit by downloading the Yale Access app.

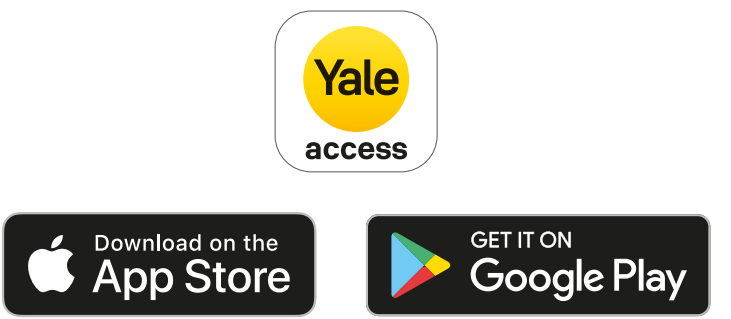

If you have any questions, please contact us at [www.yalehome.com/Linus](http://www.yalehome.com/Linus)

#### Instructions

[AR] في ترتيب تطبيق Yale Access للحصول على تعليمات الإعداد

[BG] За съвместимост на телефон, моля, проверете - [www.yalehome.com/yaleaccess](http://www.yalehome.com/yaleaccess)

[CZ] Stáhněte si aplikaci Yale Access, kde najdete pokyny k nastavení

[DA] Download appen Yale Access til opsættingsinstruktioner

[DE] Lade die App Yale Access herunter, um Anweisungen zur Einrichtung zu erhalten

[EE] Seadistujuhiste saamiseks laadige alla rakendus Yale Access

[EL] Κάντε λήψη της εφαρμογής Yale Access για οδηγίες εγκατάστασης

[EN] Download the "Yale Access" app for setup instructions

[FI] Lataa Yale Access -sovellus lähikäsiäsi asennusohjeet

[FR] Téléchargez l'application Yale Access pour obtenir les instructions d'installation

[HE] לקבלת הוראות התקנה, הורד את האפליקציה Yale Access

[HR] Preuzmite "Yale Access" aplikaciju za upute o konfiguraciji

[HU] Töltse le a Yale Access alkalmazást telefonjára a telepítési utasítások megtekintéséhez

[IT] Scarica l'app Yale Access per le istruzioni di installazione

[LV] Lejuplādējiet lietotni Yale Access, lai iegūtu iestatīšanas instrukcijas

[LT] Atsisakykite programą Yale Access, kad gautumėte sąrankos instrukcijas

[MT] Nizzel l-app Yale Access għal struzzjonijiet ta' installazzjoni

[NL] Download de app Yale Access voor installatie-instructies

[PL] Pobierz aplikację Yale Access, aby uzyskać instrukcje konfiguracji

[PT] Faça o download do aplicativo Yale Access para obter instruções de configuração

[RO] Descărcati aplicația „Yale Access” pentru a obține instrucțiunile de instalare

[SK] Ak chcete získat pokyny na nastavenie, stiahnite si aplikáciu Yale Access

[SL] Prenesite aplikacijo Yale Access za navodila za nastavitve

[SV] Ladda ner appen Yale Access för installationsinstruktioner

[TR] Kurulum talimatları için "Yale Access" uygulamasını indirin

#### Phone Compatibility

[AR] يرجى التحقق من توافق الهاتف المحمول مع هذا المنتج

[BG] За съвместимост на телефон, моля, проверете - [www.yalehome.com/yaleaccess](http://www.yalehome.com/yaleaccess)

[CZ] Kompatibilitu s telefonem nalezíte na adrese [www.yalehome.com/yaleaccess](http://www.yalehome.com/yaleaccess)

[DE] Eine Liste kompatibler Smartphones gibt es auf: [www.yalehome.com/yaleaccess](http://www.yalehome.com/yaleaccess)

[DK] Kontroller - [www.yalehome.com/yaleaccess](http://www.yalehome.com/yaleaccess) for telefonkompatibilitet

[EE] Telefoni ühilduvuse kohta saate teavet aadressil [www.yalehome.com/yaleaccess](http://www.yalehome.com/yaleaccess)

[EN] For phone compatibility, please check - [www.yalehome.com/yaleaccess](http://www.yalehome.com/yaleaccess)

[ES] Para conocer la compatibilidad del teléfono, consulta - [www.yalehome.com/yaleaccess](http://www.yalehome.com/yaleaccess)

[FI] Tarkista puhelimen yhteensopivuus - [www.yalehome.com/yaleaccess](http://www.yalehome.com/yaleaccess)

[FR] Pour vérifier la compatibilité de votre téléphone, veuillez-vous rendre ici - [www.yalehome.com/yaleaccess](http://www.yalehome.com/yaleaccess)

[HE] -פרו כיון תאמתה תאמתה תאמתה

[HR] Za kompatibilnost telefona provjerite - [www.yalehome.com/yaleaccess](http://www.yalehome.com/yaleaccess)

[HU] Ha a kompatibilitás del telefonó, konzultál - [www.yalehome.com/yaleaccess](http://www.yalehome.com/yaleaccess)

[IT] Non diammi su i nomi appie telefono sudordinum, appianki kile ovetanije [www.yalehome.com/yaleaccess](http://www.yalehome.com/yaleaccess)

[LV] Lai uzzinātu par tālruna saderību, lūdz, pārbaudiet - [www.yalehome.com/yaleaccess](http://www.yalehome.com/yaleaccess)

[MT] Chaik-kompatibilità tat-telefon, jekk jingħos i-ccikla - [www.yalehome.com/yaleaccess](http://www.yalehome.com/yaleaccess)

[NL] Kijk voor telefooncompatibiliteit op [www.yalehome.com/yaleaccess](http://www.yalehome.com/yaleaccess)

[NO] For telefonkompatibilitet, vennligst sjekk - [www.yalehome.com/yaleaccess](http://www.yalehome.com/yaleaccess)

[PL] Aby sprawdzić kompatybilność telefonu, sprawdź - [www.yalehome.com/yaleaccess](http://www.yalehome.com/yaleaccess)

[PT] Para compatibilidade do telefone, verifique - [www.yalehome.com/yaleaccess](http://www.yalehome.com/yaleaccess)

[RO] Pentru compatibilitatea telefonului, vă rugăm să verificați - [www.yalehome.com/yaleaccess](http://www.yalehome.com/yaleaccess)

[SI] Glede združljivosti telefona preverite - [www.yalehome.com/yaleaccess](http://www.yalehome.com/yaleaccess)

[SV] För telefonkompatibilitet, kontrollera - [www.yalehome.com/yaleaccess](http://www.yalehome.com/yaleaccess)

[TR] Telefon uyumluluğu için listelen kontrol ediniz - [www.yalehome.com/yaleaccess](http://www.yalehome.com/yaleaccess)

#### Legal Guarantee

[AR] يرجى التحقق من شروط الضمان الخاصة بهذا المنتج

[BG] Можете да намерите гаранционните условия за продукта тук: [www.yalehome.com/yaleaccess/guarantee](http://www.yalehome.com/yaleaccess/guarantee)

[CZ] Můžete najít podmínky záruky zde: [www.yalehome.com/yaleaccess/guarantee](http://www.yalehome.com/yaleaccess/guarantee)

[DE] Garantiebedingungen finden Sie unter: [www.yalehome.com/yaleaccess/guarantee](http://www.yalehome.com/yaleaccess/guarantee)

[DK] Produktgarantibetingelser findes her: [www.yalehome.com/yaleaccess/guarantee](http://www.yalehome.com/yaleaccess/guarantee)

[EE] Toote garantiiingused leiad si: [www.yalehome.com/yaleaccess/guarantee](http://www.yalehome.com/yaleaccess/guarantee)

[EN] Product guarantee terms and conditions can be found here: [www.yalehome.com/yaleaccess/guarantee](http://www.yalehome.com/yaleaccess/guarantee)

[ES] Los términos y condiciones de la garantía del producto se pueden encontrar aquí: [www.yalehome.com/yaleaccess/guarantee](http://www.yalehome.com/yaleaccess/guarantee)

[FI] Tuotteen takuuehdotukset löydät täältä: [www.yalehome.com/yaleaccess/guarantee](http://www.yalehome.com/yaleaccess/guarantee)

[FR] Vous pouvez trouver les conditions de garantie du produit ici: [www.yalehome.com/yaleaccess/guarantee](http://www.yalehome.com/yaleaccess/guarantee)

[HE] -הנחיות הן: [www.yalehome.com/yaleaccess/guarantee](http://www.yalehome.com/yaleaccess/guarantee)

[HR] Ovdem možete pronaći uvjete garancije proizvoda: [www.yalehome.com/yaleaccess/guarantee](http://www.yalehome.com/yaleaccess/guarantee)

[HU] Itt megtekintheti a termék garanciafeltételeit: [www.yalehome.com/yaleaccess/guarantee](http://www.yalehome.com/yaleaccess/guarantee)

[IT] I termini e le condizioni di garanzia del prodotto sono disponibili su: [www.yalehome.com/yaleaccess/guarantee](http://www.yalehome.com/yaleaccess/guarantee)

[LV] Informācija apie produkta garantiju rasiet šeit: [www.yalehome.com/yaleaccess/guarantee](http://www.yalehome.com/yaleaccess/guarantee)

[MT] Il-termini tal-Garanzija tal-Prodott għall-prodott huwa: [www.yalehome.com/yaleaccess/guarantee](http://www.yalehome.com/yaleaccess/guarantee)

[NL] Informatie over productgarantie is te vinden op: [www.yalehome.com/yaleaccess/guarantee](http://www.yalehome.com/yaleaccess/guarantee)

[NO] Vilkår og betingelser for produktgaranti finnes her: [www.yalehome.com/yaleaccess/guarantee](http://www.yalehome.com/yaleaccess/guarantee)

[PL] Warunki gwarancji produktu można znaleźć tutaj: [www.yalehome.com/yaleaccess/guarantee](http://www.yalehome.com/yaleaccess/guarantee)

[PT] Os termos de garantia do produto podem ser encontrados aqui: [www.yalehome.com/yaleaccess/guarantee](http://www.yalehome.com/yaleaccess/guarantee)

[RO] Termenii de garanție ai produselor găsiți aici: [www.yalehome.com/yaleaccess/guarantee](http://www.yalehome.com/yaleaccess/guarantee)

[SI] Garancijske pogoje za izdelke najdete tukaj: [www.yalehome.com/yaleaccess/guarantee](http://www.yalehome.com/yaleaccess/guarantee)

[SV] Informationen och villkor för produktgaranti finns under: [www.yalehome.com/yaleaccess/guarantee](http://www.yalehome.com/yaleaccess/guarantee)

[TR] Ürün garantisiyle ilgili bilgileri buradan ulaşabilirsiniz: [www.yalehome.com/yaleaccess/guarantee](http://www.yalehome.com/yaleaccess/guarantee)

# Artwork, Linus, Installation Manual, Version 1

DRAWING NO. ??????

DEFAULT TOLERANCES  
Decimal .X ± .25  
.XX ± .1

# ASSA ABLOY

Colour match  
**PANTONE 116 C**

Page 2 of 2

Unless otherwise specified, dimensions are in mm.

DRAWING BY  
Angelique Charbonnier

DATE  
07/07/2020