

# Installation Guide



Go to **[august.com/install](https://august.com/install)**  
to watch a video version  
of this installation guide.

# Welcome!

This guide will get you up and running with your August Smart Lock. Installation generally takes less than 15 minutes. If you have any trouble, please check our support section ([august.com/support](https://www.august.com/support)), contact our installer network ([august.com/installers](https://www.august.com/installers)) or call 844-AUGUST1 (284-8781) for help.

# Preparation

Make sure your existing deadbolt is compatible with the August Smart Lock. Only standard deadbolts are supported. Use our compatibility assistant to double-check: [august.com/compatibility](https://www.august.com/compatibility)

## TOOLS NEEDED



You will need a standard Phillips screwdriver.

Alternately, we have a network of installers who can help with installation. [august.com/installers](https://www.august.com/installers)

## Compatibility

**YES**

### Standard

Deadbolt is mounted and operates independently of the door handle.

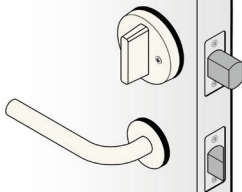

**NO**

### Integrated Lock & Handle

Handle and lock thumb-latch are both mounted together on a metal plate

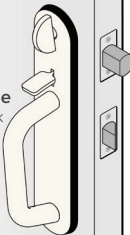

**NO**

### Mortise

An integrated door handle and deadbolt in a single metal unit

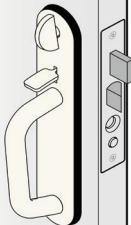

**NO**

### Rim Cylinder

Mounted, on top of the door and door jamb



# Package Contents



**1 August Smart Lock  
(4 AA Batteries Pre-installed)**

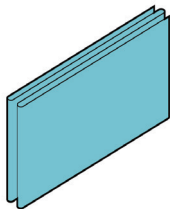

**1 Adhesive Strip  
(Inside Envelope)**



**4 Adhesive Rubber Bumpers  
(Inside Envelope)**



3 Adapters

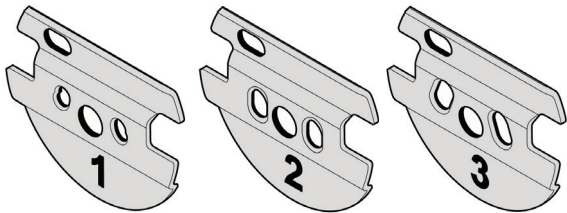

3 Mounting Plates

# Installation Overview

## Before Installation

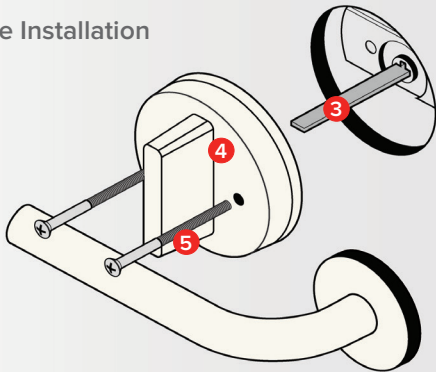

- 1 Key Hole
- 2 Deadbolt
- 3 Tail Piece
- 4 Thumb-latch
- 5 Screws

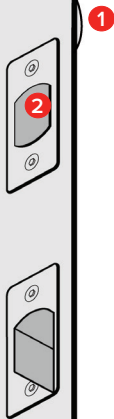



## After Installation

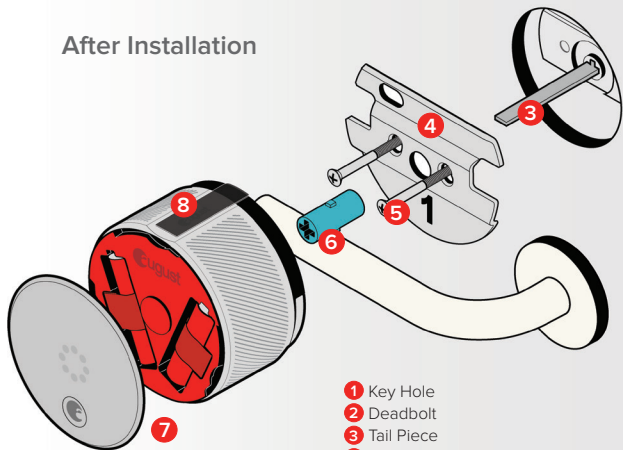

- 1 Key Hole
- 2 Deadbolt
- 3 Tail Piece
- 4 Mounting Plate
- 5 Screws
- 6 Tail Piece Adapter
- 7 August Smart Lock & Faceplate
- 8 Calibration Tape



## Step 1: Prepare existing deadbolt.

Affix the supplied adhesive strip over the key hole, securing it to the exterior side of your door. This should hold the key hole in place when you remove the thumb-latch on the inside of the door.

On some doors, such as those with glossy paint, the included tape may not be strong enough. In this case you should apply additional stronger tape to ensure that the key hole stays in place. Use caution. Some types of tape, such as duct tape, may damage the paint on certain types of doors.

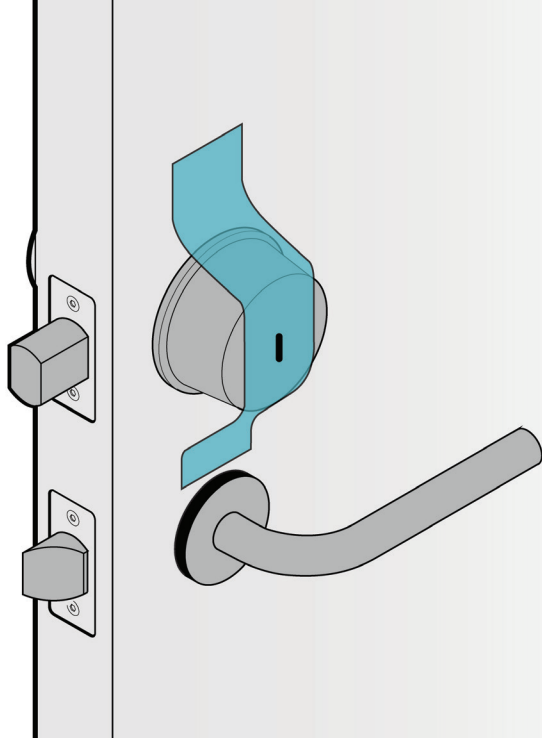

## Step 2: Remove your existing thumb-latch.

**A** Position your thumb-latch so that you can unscrew the existing screws on your deadbolt.

Remove the screws entirely from the deadbolt and keep them to assist in the next step.

After removing the screws, be sure to unlock your deadbolt before removing the thumb-latch.

**B** Your thumb-latch may include an additional back plate underneath it. If so, remove the back plate. Use the back plate and the longer screws for the next step.

**A**

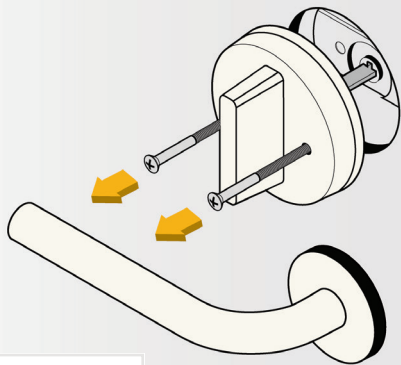

**B**

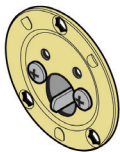









## Step 3: Select the correct mounting plate and adapter.

If you know the brand of your deadbolt, please select the correct mounting plate and adapter from the Compatibility Chart on the next page, and then go to **Step 4** (page 18).

If not, go to **Step 3a** (page 16) to find the correct mounting plate and adapter.

# Standard Deadbolt Compatibility Chart

BRAND	MOUNTING PLATE	ADAPTER
Baldwin - Estate/Images*	1	
Baldwin Reserve/Prestige	3	
Defiant	2	
Emtek	3	
Kwikset*	3	
Omnia**	1	
Schlage***	2	
Weiser	2	
Weslock	1	

\* Baldwin and Kwikset Deadbolts installed before 1997 have unique installation requirements, please contact us at 844-AUGUST1 (284-8781) and we will walk you through installation.

\*\* Compatible only with non-mortise, standard Omnia deadbolts.

\*\*\* Commercial grade Schlage B560 deadbolts require supplemental screws. If your Schlage screws are too short please contact us at support@august.com

## Step 3a: Select the correct mounting plate.

**A** Insert the existing screws in the thumb-latch to help you choose the correct mounting plate. If there was a back plate under your thumb-latch, insert the screws into this back plate instead of the thumb-latch.

**B** Slide the mounting plates onto the screws one at a time until you find a mounting plate that allows the screws to fit straight through the holes.

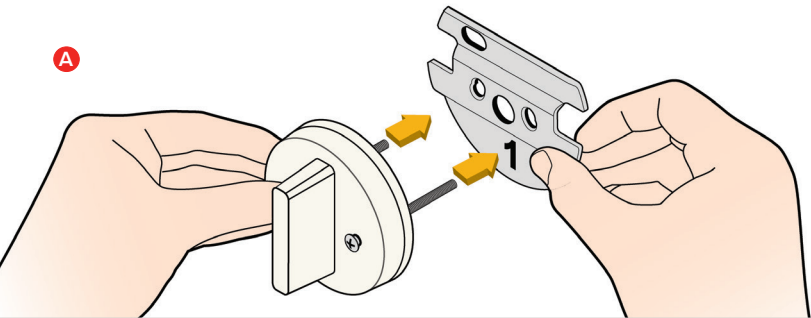

**A****B**

1.

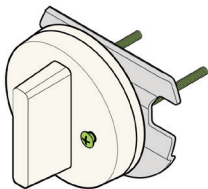

COMPATIBLE

2.

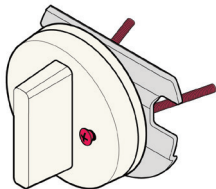

NOT COMPATIBLE

Having trouble selecting the right mounting plate? Try [august.com/installation](http://august.com/installation) or call August customer support at 844-AUGUST1 (284-8781)

## Step 4: Position the mounting plate.

- A** Remove the backing from the 4 rubber bumpers and place them on the **back side** of the mounting plate (the side that does **not** show a number).
- B** Remove the screws from the thumb-latch and use them to install the mounting plate over the existing deadbolt tail piece.
- C** **Do not fully tighten the screws. Over-tightening can deform the mounting plate and interfere with the operation of the lock.**

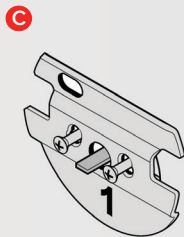
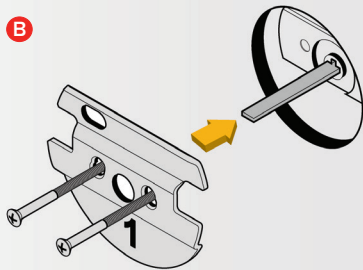
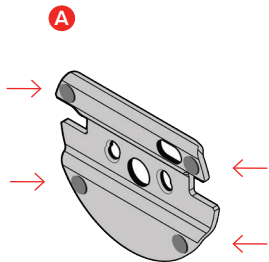

## Step 5: Position adapter and align mounting plate.

- A** Remove the tape from the key hole, and use your key to turn your deadbolt to the fully **unlocked position**.
- B** If your lock was not in the Compatibility Chart, select the adapter that fits your tail piece. To do this, slide each adapter onto the tail piece. **The correct adapter will have the small nub pointing up.**
- C** Place the correct adapter onto the tail piece with the small nub pointing up. Tighten the screws until they are just tight. **Do not over-tighten.** Over-tightening can deform the mounting plate and interfere with the operation of the lock.

**A****B**

Front View

Deadbolt Tail Piece

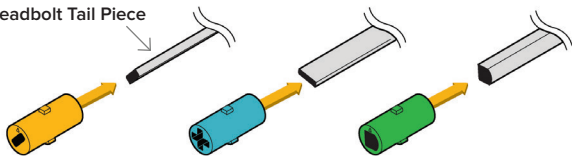

Adapter Alignment

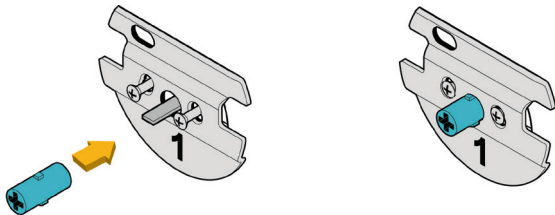
**C**

Having trouble selecting the right adapter?  
 Call August customer support at 844-AUGUST1 (284-8781)

## Step 6: Attach the August Smart Lock.

- A** Insert the adapter into the back of the August Smart Lock, then position the August Smart Lock with the curved notch at the top.
  
- B** Pull out both side wing latches. Slide the August Smart Lock over tail piece and attach to mounting plate.  
**Make sure the back of the lock is flush with the door.**
  
- C** To secure the August Smart Lock, clamp down both side wing latches to the mounting plate completely. If the latches are difficult to clamp down, then go back to Step 5C and ensure that the screws have **not been over-tightened**. You may need to loosen them slightly.

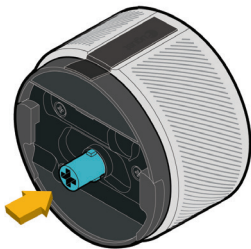
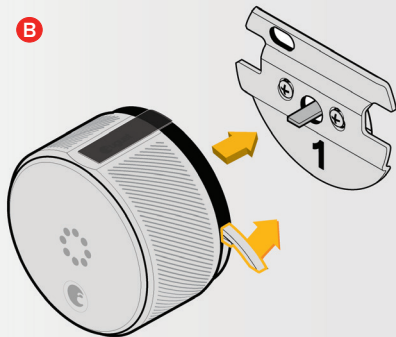
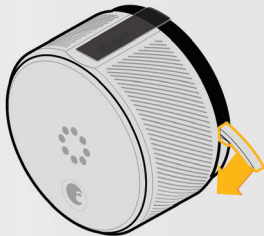
**A****B****C**

## Step 7: Remove battery tab.

- A** Press down on the face plate and rotate it **counterclockwise** to open the battery compartment. (Don't remove the factory seal until instructed to do so during the calibration process.)
  
- B** Holding batteries in place, remove the plastic battery isolation tab. Make sure that the battery is properly seated in its compartment.
  
- C** Align faceplate hooks with the August Smart Lock. The faceplate will lock into place with the logo at the bottom.



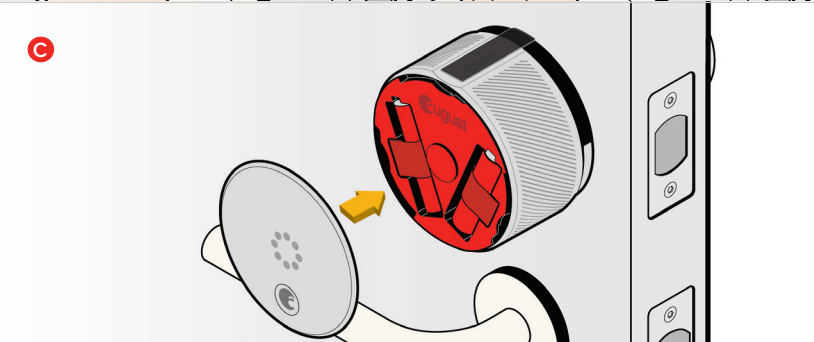
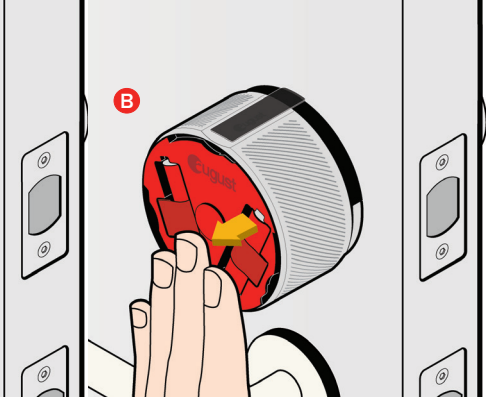
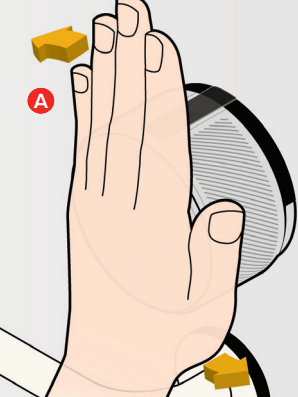

## Step 8: Install August App

Download the App from **[august.com/app](https://august.com/app)**

The app will help you create an account and set up your August Smart Lock.

We suggest that you protect your phone with a passcode in case it is lost or stolen.



# Questions?

If you have any questions or difficulties, visit [august.com/support](http://august.com/support) or call **844-AUGUST1 (284-8781)**

Lost your phone? Go to [august.com](http://august.com) to disable the August app running on your phone.

©2014 August Home Inc.